

AREA LIGHT(JCLAL08)

Specifications

Construction:

- The rugged, one-piece die-cast aluminum housing features a complete heat sink that optimizes heat dissipation through convection cooling management.
- Low profile, 3G vibration rated compact design minimizes wind load requirements.
- Housing is completely sealed against moisture and environmental contaminants.

Optics:

- Available in IES Type II, III, IV, V distributions
- Light engines are available in adjustable color temperature (3000K&4000K&5000K) configurations.
- Scalable Lumen Packages from 6,600 to 64,000 Lumens replaces up to 1000W Metal Halide.
- Optics is precisely designed to shape the distribution, maximizing efficiency and application spacing.
- The optics can conform to dark sky requirement.

Electrical:

- Universal 120-277 VAC or 347-480 VAC input voltage
- 10KA(@120-277V) or 20KA(@347-480V) surge protection
- 0-10V dimming driver standard for 10% to 100% dimming
- Power adjustable: 100%, 80%, 60%, 40%.
- THD: ≤20%
- Power Factor: ≥90%

Controls:

- Optional Occupancy sensor or Microwave sensor or daylight sensor.
- Optional Bluetooth sensor or Bluetooth controller.
- Silvair Luminaire Level Lighting Control (LLLC) optional.
- Sharkward Luminaire Level Lighting Control (LLLC) optional.
- Also compatible with 3rd party smart network control system.
- Optional NEMA 3-pin photocell or 7-pin photocell.
- Optional for Integral Sensor Receptacle.

Ambient Temperature:

- Ambient operating temperature -40°C to 45°C (-40°F to 113°F).

Installation:

- Suitable for mounting heights ranging from 26-50' in area lighting applications
- Round pole, Square pole, slipfitter, wall mount and yoke are available.
- The design can be operated by one person to install the whole lamp

Lifespan:

- Estimated 100,000-hour LED lifespan based on IES LM-80 results and TM-21 calculations

Medium Size: 100W/140W/180W



Large Size: 250W/300W/400W



Certifications:

- UL wet location listed
 - DesignLights Consortium™ Qualified for Outdoor Pole/Arm-Mounted Area and Roadway Luminaires, Architectural Flood and Spot Luminaires.
- Note: DesignLights Consortium™ Qualified and classified for DLC Premium, refer to www.designlights.org for details.

Note:

Actual performance may differ as a result of end-user environment and application. All values are design or typical values, measured under laboratory conditions at 25°C (±5°C) specifications subject to change without notice.

Finish:

- It's available in black or optional dark bronze, silvery gray or white.



Structural Design

Housing

The one-piece die-cast housing with corrosion-resistant coating protection and the modular design extend the life of the luminaire while making it easy to maintain.

Photometry

Optional Type II, Type III, Type IV and Type V Photometry as per applications.

Photocell

Dusk to dawn controls can be utilized via optional NEMA twist-lock photocell.

Occupancy Sensor

Optional occupancy sensor allows for security and energy saving.

CCT & POWER Adjustable

Offer four selectable lumen output (40%/60%/80%/100%), and three selectable CCTs (30K/40K/50K)

POWER	CCT
LV1	5KK
LV2	4KK
LV3	3KK
LV4	

Mounting

Optional for square, round pole mount, Slipfitter, wall mount, yoke mount. All mounting brackets are simple to operate, which can realize single operation and reduce labor costs.

PERFORMANCE DATA

JCL08-100W									
SETTING	SYSTEM WATTS	DIST.TYPE	CRI	3000K		4000K		5000K	
				LUMENS	LPW	LUMENS	LPW	LUMENS	LPW
100%	100W	2	70	14500lm	145 lm/W	15800lm	158 lm/W	15000lm	150 lm/W
		3	70	14500lm	145 lm/W	15800lm	158 lm/W	15000lm	150 lm/W
		4	70	14500lm	145 lm/W	15800lm	158 lm/W	15000lm	150 lm/W
		5	70	15100lm	151 lm/W	16000lm	160 lm/W	15600lm	156 lm/W
80%	80W	2	70	12000lm	150 lm/W	13000lm	163 lm/W	12500lm	156 lm/W
		3	70	12000lm	150 lm/W	13000lm	163 lm/W	12500lm	156 lm/W
		4	70	12000lm	150 lm/W	13000lm	163 lm/W	12500lm	156 lm/W
		5	70	12500lm	156 lm/W	13300lm	166 lm/W	12800lm	160 lm/W
60%	60W	2	70	9300lm	155 lm/W	10000lm	167 lm/W	9600lm	160 lm/W
		3	70	9300lm	155 lm/W	10000lm	167 lm/W	9600lm	160 lm/W
		4	70	9300lm	155 lm/W	10000lm	167 lm/W	9600lm	160 lm/W
		5	70	9600lm	160 lm/W	10200lm	170 lm/W	9850lm	164 lm/W
40%	40W	2	70	6400lm	160 lm/W	6800lm	170 lm/W	6560lm	164 lm/W
		3	70	6400lm	160 lm/W	6800lm	170 lm/W	6560lm	164 lm/W
		4	70	6400lm	160 lm/W	6800lm	170 lm/W	6560lm	164 lm/W
		5	70	6560lm	164 lm/W	7000lm	175 lm/W	6700lm	168 lm/W

JCL08-140W									
SETTING	SYSTEM WATTS	DIST.TYPE	CRI	3000K		4000K		5000K	
				LUMENS	LPW	LUMENS	LPW	LUMENS	LPW
100%	140W	2	70	20000lm	147 lm/W	23000lm	164 lm/W	21000lm	150 lm/W
		3	70	20000lm	147 lm/W	23000lm	164 lm/W	21000lm	150 lm/W
		4	70	20000lm	147 lm/W	23000lm	164 lm/W	21000lm	150 lm/W
		5	70	21000lm	150 lm/W	23500lm	168 lm/W	21500lm	154 lm/W
80%	120W	2	70	18000lm	150 lm/W	20000lm	167 lm/W	18500lm	154 lm/W
		3	70	18000lm	150 lm/W	20000lm	167 lm/W	18500lm	154 lm/W
		4	70	18000lm	150 lm/W	20000lm	167 lm/W	18500lm	154 lm/W
		5	70	18500lm	154 lm/W	20500lm	171 lm/W	19000lm	158 lm/W
60%	90W	2	70	13800lm	153 lm/W	15200lm	169 lm/W	14200lm	158 lm/W
		3	70	13800lm	153 lm/W	15200lm	169 lm/W	14200lm	158 lm/W
		4	70	13800lm	153 lm/W	15200lm	169 lm/W	14200lm	158 lm/W
		5	70	14000lm	156 lm/W	15600lm	172 lm/W	14500lm	161 lm/W
40%	60W	2	70	9400lm	157 lm/W	10300lm	172 lm/W	9700lm	162 lm/W
		3	70	9400lm	157 lm/W	10300lm	172 lm/W	9700lm	162 lm/W
		4	70	9400lm	157 lm/W	10300lm	172 lm/W	9700lm	162 lm/W
		5	70	9600lm	160 lm/W	10500lm	175 lm/W	10000lm	167 lm/W

JCL08-180W									
SETTING	SYSTEM WATTS	DIST.TYPE	CRI	3000K		4000K		5000K	
				LUMENS	LPW	LUMENS	LPW	LUMENS	LPW
100%	180W	2	70	24800lm	138 lm/W	27000lm	150 lm/W	25200lm	140 lm/W
		3	70	24800lm	138 lm/W	27000lm	150 lm/W	25200lm	140 lm/W
		4	70	24800lm	138 lm/W	27000lm	150 lm/W	25200lm	140 lm/W
		5	70	25500lm	142 lm/W	28000lm	156 lm/W	26000lm	144 lm/W
80%	144W	2	70	20200lm	140 lm/W	22000lm	153 lm/W	20600lm	143 lm/W
		3	70	20200lm	140 lm/W	22000lm	153 lm/W	20600lm	143 lm/W
		4	70	20200lm	140 lm/W	22000lm	153 lm/W	20600lm	143 lm/W
		5	70	20800lm	144 lm/W	22800lm	158 lm/W	21000lm	146 lm/W
60%	108W	2	70	15300lm	142 lm/W	16800lm	156 lm/W	15700lm	145 lm/W
		3	70	15300lm	142 lm/W	16800lm	156 lm/W	15700lm	145 lm/W
		4	70	15300lm	142 lm/W	16800lm	156 lm/W	15700lm	145 lm/W
		5	70	15800lm	146 lm/W	17300lm	160 lm/W	16200lm	150 lm/W
40%	72W	2	70	10500lm	146 lm/W	11500lm	160 lm/W	10800lm	150 lm/W
		3	70	10500lm	146 lm/W	11500lm	160 lm/W	10800lm	150 lm/W
		4	70	10500lm	146 lm/W	11500lm	160 lm/W	10800lm	150 lm/W
		5	70	10800lm	150 lm/W	11800lm	164 lm/W	11000lm	153 lm/W

JCL08-250W									
SETTING	SYSTEM WATTS	DIST.TYPE	CRI	3000K		4000K		5000K	
				LUMENS	LPW	LUMENS	LPW	LUMENS	LPW
100%	250W	2	70	33500lm	134 lm/W	37000lm	148 lm/W	34500lm	138 lm/W
		3	70	33500lm	134 lm/W	37000lm	148 lm/W	34500lm	138 lm/W
		4	70	33500lm	134 lm/W	37000lm	148 lm/W	34500lm	138 lm/W
		5	70	34500lm	138 lm/W	38000lm	152 lm/W	35500lm	142 lm/W
80%	200W	2	70	27500lm	138 lm/W	30400lm	152 lm/W	28400lm	142 lm/W
		3	70	27500lm	138 lm/W	30400lm	152 lm/W	28400lm	142 lm/W
		4	70	27500lm	138 lm/W	30400lm	152 lm/W	28400lm	142 lm/W
		5	70	28000lm	140 lm/W	31000lm	155 lm/W	28800lm	144 lm/W
60%	150W	2	70	21300lm	142 lm/W	23200lm	155 lm/W	21800lm	145 lm/W
		3	70	21300lm	142 lm/W	23200lm	155 lm/W	21800lm	145 lm/W
		4	70	21300lm	142 lm/W	23200lm	155 lm/W	21800lm	145 lm/W
		5	70	21800lm	145 lm/W	23800lm	159 lm/W	22500lm	150 lm/W
40%	100W	2	70	14500lm	145 lm/W	16000lm	160 lm/W	14800lm	148 lm/W
		3	70	14500lm	145 lm/W	16000lm	160 lm/W	14800lm	148 lm/W
		4	70	14500lm	145 lm/W	16000lm	160 lm/W	14800lm	148 lm/W
		5	70	15000lm	150 lm/W	16500lm	165 lm/W	15500lm	155 lm/W

JCL08-300W									
SETTING	SYSTEM WATTS	DIST.TYPE	CRI	3000K		4000K		5000K	
				LUMENS	LPW	LUMENS	LPW	LUMENS	LPW
100%	300W	2	70	41000lm	137 lm/W	45000lm	150 lm/W	42000lm	140 lm/W
		3	70	41000lm	137 lm/W	45000lm	150 lm/W	42000lm	140 lm/W
		4	70	41000lm	137 lm/W	45000lm	150 lm/W	42000lm	140 lm/W
		5	70	42500lm	142 lm/W	46000lm	153 lm/W	43500lm	145 lm/W
80%	240W	2	70	33600lm	140 lm/W	37000lm	154 lm/W	34500lm	144 lm/W
		3	70	33600lm	140 lm/W	37000lm	154 lm/W	34500lm	144 lm/W
		4	70	33600lm	140 lm/W	37000lm	154 lm/W	34500lm	144 lm/W
		5	70	34500lm	144 lm/W	38000lm	158 lm/W	35500lm	148 lm/W
60%	180W	2	70	26000lm	144 lm/W	28600lm	159 lm/W	26600lm	148 lm/W
		3	70	26000lm	144 lm/W	28600lm	159 lm/W	26600lm	148 lm/W
		4	70	26000lm	144 lm/W	28600lm	159 lm/W	26600lm	148 lm/W
		5	70	26600lm	148 lm/W	29700lm	165 lm/W	27500lm	153 lm/W
40%	120W	2	70	18000lm	150 lm/W	20000lm	167 lm/W	18500lm	154 lm/W
		3	70	18000lm	150 lm/W	20000lm	167 lm/W	18500lm	154 lm/W
		4	70	18000lm	150 lm/W	20000lm	167 lm/W	18500lm	154 lm/W
		5	70	18500lm	154 lm/W	20800lm	173 lm/W	19000lm	158 lm/W

JCL08-400W							
SETTING	SYSTEM WATTS	DIST.TYPE	CRI	4000K		5000K	
				LUMENS	LPW	LUMENS	LPW
LV1	400W	2	70	62500lm	156 lm/W	61500lm	154 lm/W
		3	70	62500lm	156 lm/W	61500lm	154 lm/W
		4	70	62000lm	155 lm/W	61000lm	153 lm/W
		5	70	64000lm	160 lm/W	63000lm	158 lm/W
LV2	360W	2	70	57500lm	160 lm/W	56500lm	157 lm/W
		3	70	57500lm	160 lm/W	56500lm	157 lm/W
		4	70	57000lm	158 lm/W	56000lm	156 lm/W
		5	70	59000lm	164 lm/W	58000lm	161 lm/W
LV3	320W	2	70	52500lm	160 lm/W	51500lm	161 lm/W
		3	70	52500lm	160 lm/W	51500lm	161 lm/W
		4	70	52000lm	163 lm/W	51000lm	159 lm/W
		5	70	53500lm	167 lm/W	52500lm	164 lm/W
LV4	300W	2	70	48500lm	167 lm/W	47500lm	164 lm/W
		3	70	48500lm	167 lm/W	47500lm	164 lm/W
		4	70	48000lm	166 lm/W	47000lm	162 lm/W
		5	70	49500lm	171 lm/W	48500lm	167 lm/W

BUG @5000K

SYSTEM WATTS	VOLTAGE	DIST. TYPE	B	U	G
100W	120-277V/347-480V	2	3	0	3
		3	3	0	3
		4	3	0	2
		5	4	0	2
140W	120-277V/347-480V	2	3	0	3
		3	3	0	3
		4	3	0	3
		5	4	0	2
180W	120-277V/347-480V	2	4	0	3
		3	3	0	3
		4	3	0	3
		5	4	0	2
250W	120-277V/347-480V	2	4	0	4
		3	4	0	4
		4	4	0	3
		5	5	0	3
300W	120-277V/347-480V	2	5	0	4
		3	4	0	4
		4	4	0	4
		5	5	0	4
400W	120-277V/347-480V	2	5	0	4
		3	5	0	5
		4	5	0	5
		5	5	0	5

ELECTRICAL DATA

Number Of Drivers	Driver Current (mA)	Nominal Power (W)	INPUT VOLTAGE (V)	CURRENT (Amps)
1	850	100	120	0.83
		100	208	0.48
		100	240	0.42
		100	277	0.36
	2520	100	347	0.29
		100	480	0.21
1	1200	140	120	1.17
		140	208	0.67
		140	240	0.58
		140	277	0.51
		140	347	0.40
		140	480	0.29
1	960	180	120	1.50
		180	208	0.87
		180	240	0.75
		180	277	0.65
		180	347	0.52
		180	480	0.38
1	1200	250	120	2.08
		250	208	1.20
		250	240	1.04
		250	277	0.90
		250	347	0.72
		250	480	0.52
1	1500	300	120	2.50
		300	208	1.44
		300	240	1.25
		300	277	1.08
		300	347	0.86
		300	480	0.63
1	1460	400	120	3.33
		400	208	1.92
		400	240	1.67
		400	277	1.44
		400	347	1.15
		400	480	0.83

MOUNTING

- Standard versatile mounting arm accommodates multiple drilling patterns as well as square and round poles
- Optional for cast aluminum slipfitter mounting adapter (Compatible with more mounting adaptors such as Tenon, suits for various application)

Mounting Options



Arm Mount
(4" and 5" Square and Round poles)
Standard versatile mounting arm is simple to install and can be used with existing poles for retrofit installations.



Slipfitter Mount
An optional cast aluminum mast arm adapter secures fixture head to nominal 2-3/8" O.D. horizontal steel tenon arm.



Wall Mount
Wall Mount is easy to install for direct wall mounting with 1/2" conduit wiring or standard J-box mounting



Yoke Mount
Die-cast aluminum trunnion is easily adapted to many surfaces and allows easy fixture aiming angles.



Adjustable Arm Mount
Standard versatile mounting arm is simple to install and can be used with existing poles for retrofit installations.

Mounting Dimensions

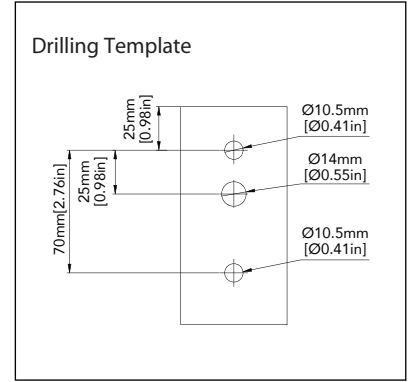
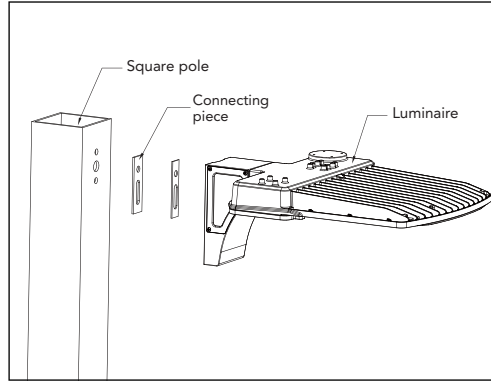
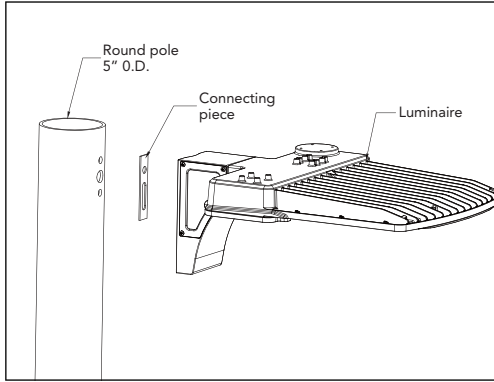

DIMENSION

unit: inch/mm

100W/140W/180W (Adjustable Square Mount)

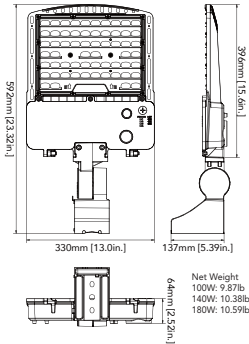

100W/140W/180W (Slipfitter Mount)

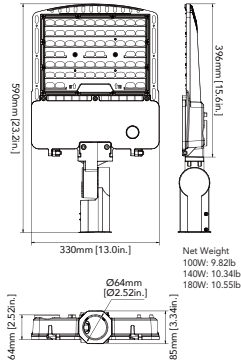

100W/140W/180W (Wall Mount)

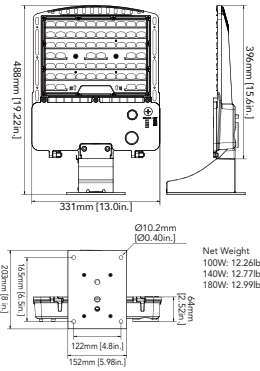

100W/140W/180W (Pole Mount)

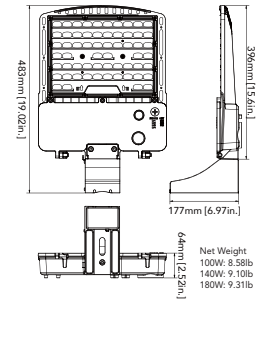

100W/140W/180W (Yoke Mount)

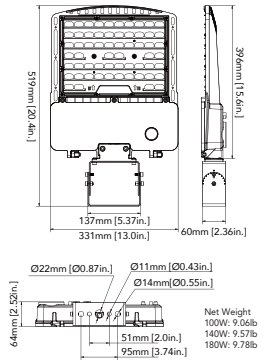

250W/300W/400W (Adjustable Square Mount)

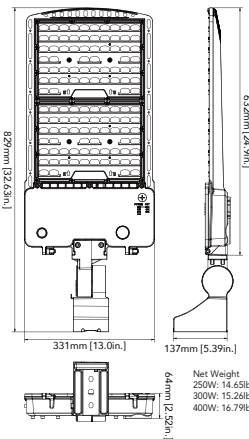

250W/300W/400W (Slipfitter Mount)

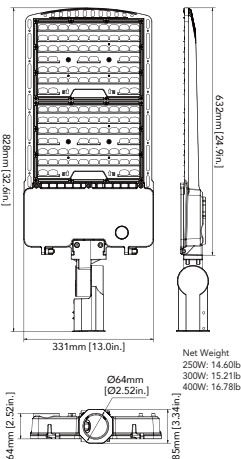

250W/300W/400W (Wall Mount)

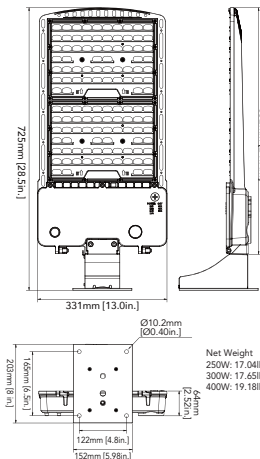



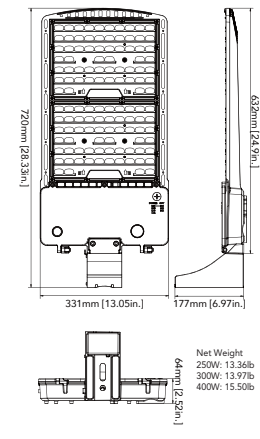

250W/300W/400W (Pole Mount)

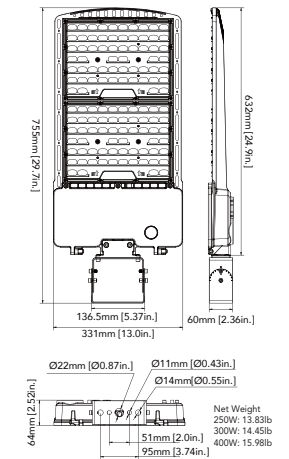

250W/300W/400W (Yoke Mount)

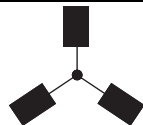
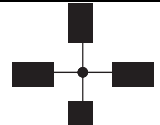

EPA OF AREA LIGHT

Item							
100W/140W/180W	0.3632	0.6849	0.8861	0.7264	1.0481	1.2078	1.0481
250W/300W/400W	0.4758	0.8091	1.059	0.9516	1.2849	1.3923	1.2849

PHOTOMETRICS

Offers a complete set of optical systems to meet every site lighting requirement. These systems provide remarkable flexibility in precisely matching light distribution patterns to specific site requirements.

Type 2 optics are ideal for applications where there is a need to space the luminaires farther apart along a road or pathway. The light distribution pattern is optimized for elongated areas, allowing for greater pole spacing without sacrificing lighting quality.

Type 3 optics produce an asymmetrical pattern that directs the majority of the light forward and equally on both sides of the luminaire. In a back-to-back configuration, it creates a rectangular pattern which can extend pole spacings.

Type 4 is suitable for applications where light is primarily required forward with minimal backlight. Typical installations include perimeter poles.

Type 5 optics produce a symmetrical square distribution pattern that distributes light equally on all sides of the luminaire. Type 5 luminaires is universal for most area lighting applications

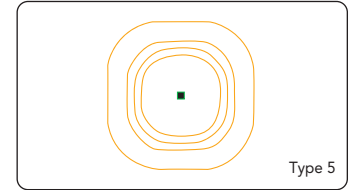
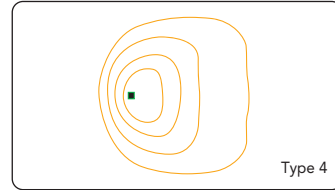
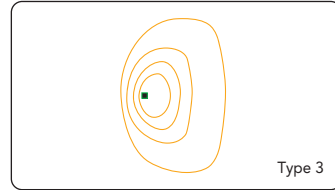
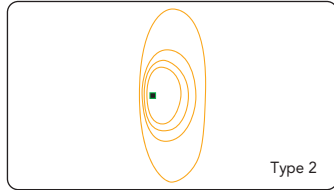

ORDERING GUIDE Example: MAL08 140W 27V XXK Y Y Y Y Y

Fixture Type	Wattage	Voltage	CCT	Finish	Photocell (Option)	Sensor (Option)	Mounting	Photometry	CCT and Power Adjustable	Internal Code
<input type="checkbox"/>	<input type="checkbox"/>	<input type="checkbox"/>	<input type="checkbox"/>	<input type="checkbox"/>	<input type="checkbox"/>	<input type="checkbox"/>	<input type="checkbox"/>	<input type="checkbox"/>	<input type="checkbox"/>	<input type="checkbox"/>
MAL08 Area Light Series	100 100W 140 140W 180 180W 250 250W 300 300W 400 400W	27V 120-277V 48V 347-480V	DDK1 Adjustable color temperature	D Dark Bronze B Black W White SG Silver Gray	P0 120-277V Photocell P3 347V Photocell P4 480V Photocell Blank Without Photocell	M With Sensor Blank Without Sensor	SQ Square Pole Mount SP Slipfitter Mount WM Wall Mount YK Yoke Mount SQA Adjustable Square Mount	T2 TYPE II T3 TYPE III T4 TYPE IV T5 TYPE V	AD1 With adjustment dial Blank Without adjustment dial	Blank Alphanumeric

Note: Only 400W suit for 4000K, 5000K adjustable and other wattage suit for 3000K, 4000K and 5000K adjustable.

ACCESSORIES(Optional)

AL08 series features a backlight control which provides reduced pixilation and increased visual comfort without compromising performance. External Glare Shield: sold separately or as an accessory.

			
External Glare Shield		External Glare Full Visor	
			
Plug-and-Play PIR Sensor PIR sensor: MSANT12VPH01 Bluetooth PIR sensor: MSANT12VPHB01	Plug-and-Play Microwave Sensor Microwave sensor: MSANT12VMH01 Bluetooth microwave sensor: MSANT12VMHB01	120-277V PIR Sensor PIR sensor: BRI823-B-D Bluetooth PIR sensor: BRI823-B-D-BLE-SR	NEMA Photocell 3 pin NEMA Type: MS-PSUNVB1 3 pin NEMA Type(480V): JL-207F 7 pin NEMA Type: JL-241C
			
House Side Shield	Photocell USE: 3 seconds plug-in 12-24VDC input		

ADDITIONAL MOUNTING ACCESSORIES

POLE BRACKET • For mounting one fixture on an existing pole			
	<p>4\" Square Pole Mount with 2-3/8\" O.D. Tenon No. 4SQ-SP-D Finish: Dark Bronze USE: For use with square, non-tapered steel and aluminum poles. Furnished with four 5/16\" hex head stainless-steel bolts. Vertical tenon measures 2-3/8\" O.D., and is made of steel tubing. Fixtures mounted to this bracket can be adjusted both vertically and horizontally.</p>		<p>4\" Round Pole Mount with 2-3/8\" O.D. Tenon NO. 4SR-SP-D Finish: Dark Bronze USE: For use with Round, non-tapered steel and aluminum poles. Furnished with three 3/8\" hex head stainless-steel bolts. Vertical tenon measures 2-3/8\" O.D., and is made of steel tubing. Fixtures mounted to this bracket can be adjusted both vertically and horizontally.</p>
	<p>5\" Square Pole Mount with 2-3/8\" O.D. Tenon No. 5SQ-SP-D Finish: Dark Bronze USE: For use with square, non-tapered steel and aluminum poles. Furnished with four 5/16\" hex head stainless-steel bolts. Vertical tenon measures 2-3/8\" O.D., and is made of steel tubing. Fixtures mounted to this bracket can be adjusted both vertically and horizontally.</p>		<p>5\" Round Pole Mount with 2-3/8\" O.D. Tenon NO. 5SR-SP-D Finish: Dark Bronze USE: For use with Round, non-tapered steel and aluminum poles. Furnished with three 3/8\" hex head stainless-steel bolts. Vertical tenon measures 2-3/8\" O.D., and is made of steel tubing. Fixtures mounted to this bracket can be adjusted both vertically and horizontally.</p>
	<p>Pole Bracket Accessories - Angle-Adjustment Adapter NO. SQA-ALDA Finish: Dark Bronze USE: Durable brackets are engineered to provide versatile mounting options. These arms are made from rugged die-cast aluminum. They allow optimal positioning of the light fixture to maximize the lighting effectiveness vertically and horizontally.</p>		<p>Pole Bracket accessories - Tenon & Yoke Adaptor NO. SP-TR-D Finish: Dark Bronze USE: The 2-3/8\" OD Tenon Mount Adaptor for Yoke Fixtures is designed to mount light fixtures that are equipped with a yoke mount onto a 2-3/8\" OD tenon. It may be utilized with the Flood Light Series of light fixtures.</p>
	<p>Horizontal Wall or Square or Round pole mount with 2-3/8\" Tenon Bracket NO. SQ/R-SP-D Finish: Dark Bronze USE: This tenon bracket can be installed onto a wall, square pole, round pole. Provides wiring access and built-in 2-3/8\" O.D. tenon to mount a fixture with our adjustable slipfitter. Suggested 3/8\" diameter bolts for mounting.</p>		<p>Adjustable Arm Mount Kit NO. SQADAL08-A Finish: Dark Bronze Description: Adjustable pole mount kit, suitable for 4\" & 5\" square or round pole</p>
WALL BRACKET • Attaches to any flat surface • Provides wiring access		Mid-Pole tenon Bracket	
	<p>90° Wall Mount Bracket with 2-3/8\" O.D. Tenon NO. WM-SP-D Finish: Dark Bronze USE: The 90° wall mount bracket with 2-3/8\" tenon attaches an floodlight to almost any surface: wall, roof, or wood pole. Provides wiring access and built-in 2-3/8\" O.D. tenon to mount a fixture with our adjustable slipfitter. Suggested 3/8\" diameter bolts for mounting. Mounting holes are spaced 3-1/4\" apart.</p>		<p>2-3/8\" OD Horizontal Tenon Mid-Pole Bracket NO. SQ-SP-D Finish: Dark Bronze USE: 2-3/8\" OD Horizontal Tenon Mid-Pole Bracket is designed to mount light fixture that is equipped with an adjustable slipfitter onto a 2-3/8\" OD horizontal tenon</p>
Round External Mount Horizontal Tenon • To mount 2/3/4 fixtures on a existing pole			
	<p>Double 90° Horizontal Tenon Adaptor NO. R60-SP2-90-D Finish: Dark Bronze USE: The Bracket is designed to mount over 2-3/8\" (60mm) O.D. vertical tenon. Two fixtures can be mounted to the Round External Mount Horizontal Tenon and adjusted horizontally</p>		<p>Triple 120° Horizontal Tenon Adaptor NO. R60-SP3-120-D Finish: Dark Bronze USE: The Bracket is designed to mount over 2-3/8\" (60mm) O.D. vertical tenon. Three fixtures can be mounted to the Round External Mount Horizontal Tenon and adjusted horizontally</p>
	<p>Double 180° Horizontal Tenon Adaptor NO. R60-SP2-180-D Finish: Dark Bronze USE: The Bracket is designed to mount over 2-3/8\" (60mm) O.D. vertical tenon. Two fixtures can be mounted to the Round External Mount Horizontal Tenon and adjusted horizontally</p>		<p>Quad 90° Horizontal Tenon Adaptor NO. R60-SP4-90-D Finish: Dark Bronze USE: The Bracket is designed to mount over 2-3/8\" (60mm) O.D. vertical tenon. Four fixtures can be mounted to the Round External Mount Horizontal Tenon and adjusted horizontally</p>
	<p>Triple 90° Horizontal Tenon Adaptor NO. R60-SP3-90-D Finish: Dark Bronze USE: The Bracket is designed to mount over 2-3/8\" (60mm) O.D. vertical tenon. Three fixtures can be mounted to the Round External Mount Horizontal Tenon and adjusted horizontally</p>		